

VSD50-1-LT-AZ-M-L/1175

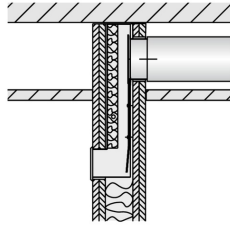

INSTALLATION IN
LIGHTWEIGHT PARTITION
WALLS WITH METAL
SUPPORT STRUCTURE



ANGLED ONE-WAY AIR
DISCHARGE

VSD50-1-LT

FOR THE SPACE SAVING INSTALLATION INTO LIGHTWEIGHT PARTITION WALLS WITH A METAL SUPPORT STRUCTURE

Slot diffusers with 50 mm diffuser face (nominal width) and adjustable air control elements

- Nominal length: 550, 1175 mm, 1 slot
- Volume flow rate range 10 – 70 l/s or 36 – 252 m³/h
- Diffuser face made of extruded aluminium sections
- For variable and constant volume flows
- Installation into lightweight partition walls with a 50 mm wide metal support structure and a wall thickness of 100 mm
- High induction results in a rapid reduction of the temperature difference and airflow velocity
- Individually adjustable air control elements to meet individual local requirements

Optional equipment and accessories

- Exposed diffuser face available in RAL CLASSIC colours
- Damper blade for volume flow rate balancing, can be adjusted through the diffuser face

Application



Application

- Type VSD50-1-LT slot diffusers are used as supply air or extract air devices or as supply and extract air combinations in comfort zones
- Angled one-way air discharge for turbulent flow (mixed flow ventilation)
- High induction results in a rapid reduction of the temperature difference and airflow velocity (supply air variant)
- For variable and constant volume flows
- For supply air to room air temperature differences from –10 to +10 K
- For room heights up to 4 m (lower edge of suspended ceiling)
- For the space saving installation into lightweight partition walls with a 50 mm wide metal support structure and a wall thickness of 100 mm

Special characteristics

- Individually adjustable air control elements to meet individual local requirements
- High induction results in a rapid reduction of the temperature difference and airflow velocity
- Diffuser face has been optimised for maximum volume flow rate at low sound power levels
- Internal acoustic lining that reduces room-to-room cross talk through the ductwork
- For easy and safe installation of the diffuser face after drywalling is complete

Nominal sizes

- L_N: 550, 1175 mm

Description



Variants

- VSD50 -1-LT: Slot diffuser for supply air or extract air
- VSD50 -1-LT-AZ: Slot diffuser as a supply and extract air combination (only L_N 1175 mm)
- VSD50 -1-LT-.../WW: White air control elements

Parts and characteristics

- Diffuser face with individually adjustable air control elements
- Plenum box for horizontal duct connection
- Internal acoustic lining to increase transmission loss
- Spring clip fixing

Attachments

- Damper blade for volume flow rate balancing

Accessories

- Lip seal

Construction features

- Spigot suitable for circular ducts to EN 1506 or EN 13180
- Spigot with groove for lip seal (if accessory lip seal has been ordered)

Materials and surfaces

- Diffuser face made from extruded aluminium sections
- Air control elements made of plastic, UL 94, V-0, flame retardant
- Plenum box made of galvanised sheet steel
- End angle made of aluminium
- Lip seal made of rubber
- Acoustic lining of the cross-talk attenuator is mineral wool
- Diffuser face with anodised finish, E6-C-0, natural colour
- P1: Powder-coated, RAL CLASSIC colour
- Air control elements similar to RAL 9005, black
- WW: Air control elements similar to RAL 9010, white

Mineral wool

- To EN 13501, fire rating class A1, non-combustible
- RAL quality mark RAL-GZ 388
- Biosoluble and hence hygienically safe according to the German TRGS 905 (Technical Rules for Hazardous Substances) and EU directive 97/69/EC
- Faced with glass fibre fabric as a protection against abrasion through airflow velocities of up to 20 m/s
- Inert to fungal and bacterial growth

Standards and guidelines

- Sound power level of the air-regenerated noise measured according to EN ISO 5135

Maintenance

- Maintenance-free as construction and materials are not subject to wear
- Inspection and cleaning to VDI 6022

TEKNISK INFORMATION

Function, Technical data, Quick sizing, SPECIFICATION TEXT, Order code



Functional description

Slot diffusers direct the air from air conditioning systems into the room, either horizontally or at an angle. The resulting airflow induces high levels of room air, thereby rapidly reducing the airflow velocity and the temperature difference between supply air and room air. The result is a mixed flow ventilation in comfort zones, with good overall room ventilation, creating only very little turbulence in the occupied zone.

Type VSD50-1-LT slot diffusers have adjustable air control elements. The air pattern can be adjusted to meet different local requirements. The supply air to room air temperature difference may range from -10 to $+10$ K.

A damper blade (optional) simplifies volume flow rate balancing for commissioning.

To give rooms an aesthetic, uniform look, Type VSD50-1-LT diffusers may also be used for extract air or as a supply and extract air combination.

Schematic illustration of VSD50-1-LT as supply and extract air combination

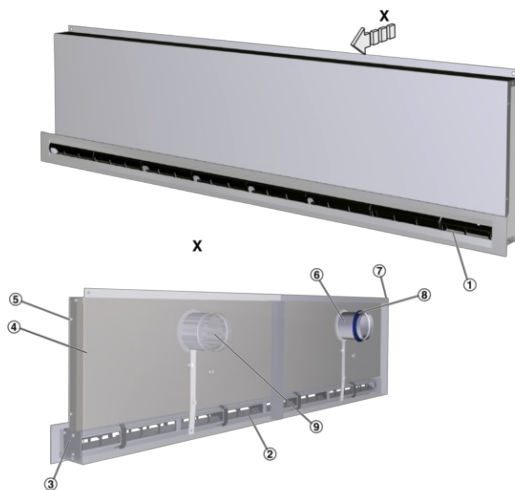

- ① Diffuser face
- ② Adjustable air control element
- ③ End angle
- ④ Plenum box with acoustic lining
- ⑤ Acoustic lining (reduces room-to-room cross talk)
- ⑥ Spigot
- ⑦ Suspension hole
- Optional
- ⑧ Lip seal
- ⑨ Damper blade for volume flow rate balancing

Angled one-way air discharge



Nominal length	550, 1175 mm
Number of slots	1
Minimum volume flow rate	10, 25 l/s or 36, 90 m³/h
Maximum volume flow rate, with $L_{WA} \cong 50$ dB(A)	35, 70 l/s or 126, 252 m³/h
Supply air to room air temperature difference	-10 to +10 K

Transmission loss

Variant	Centre frequency f_m [Hz]				
	125	250	500	1000	2000
Variant	D_t				
	dB				
VSD50-1-LT/550	16	14	15	18	22
VSD50-1-LT/1175	13	12	11	17	20
VSD50-1-LT-AZ/1175	15	13	13	17	20

Quick sizing tables provide a good overview of the volume flow rates and corresponding sound power levels and differential pressures.

The maximum volume flow rates apply to a sound power level of approx. 50 dB (A) with damper blade position 0°.

VSD50-1-LT, supply air, sound power level and total differential pressure

Nominal length	V		Damper blade position					
			0°		45°		90°	
Nominal length	V		Δp_t	L _{WA}	Δp_t	L _{WA}	Δp_t	L _{WA}
	l/s	m³/h	Pa	dB(A)	Pa	dB(A)	Pa	dB(A)
550	10	36	7	<15	11	<15	29	<15
	15	54	17	18	24	23	64	22
550	25	90	46	34	66	38	179	40
	35	126	90	45	130	47	350	51
1175	25	90	18	19	26	24	63	26
	45	162	60	36	86	40	204	42
1175	55	198	89	43	128	45	305	47
	70	252	145	50	207	52	494	54

VSD50-1-LT, extract air, sound power level and total differential pressure

Nominal length	V		Damper blade position					
			0°		45°		90°	
Nominal length	V		Δp_t	L _{WA}	Δp_t	L _{WA}	Δp_t	L _{WA}
	l/s	m³/h	Pa	dB(A)	Pa	dB(A)	Pa	dB(A)
550	10	36	7	<15	9	<15	33	18
	15	54	16	15	21	18	74	31
550	25	90	43	37	59	39	205	47
	35	126	85	51	116	53	401	58
1175	25	90	18	17	26	20	62	26
	45	162	59	34	85	38	199	42
1175	55	198	89	40	126	44	298	48
	70	252	144	47	204	51	483	54

VSD50-1-LT-AZ, supply and extract air combination, sound power level and total differential pressure

Nominal length	V		Damper blade position								
			0°			45°			90°		
Nominal length	V		Δp_t supply air	Δp_t extract air	L _{WA}	Δp_t supply air	Δp_t extract air	L _{WA}	Δp_t supply air	Δp_t extract air	L _{WA}
	l/s	m³/h	Pa		dB(A)	Pa		dB(A)	Pa		dB(A)
1175	10	36	7	6	<15	12	10	15	30	33	17
	15	54	15	13	20	26	23	26	68	75	29
1175	25	90	43	35	36	72	64	40	188	208	45
	40	144	110	90	50	186	163	53	482	532	61

Slot diffusers with individually manually adjustable air control elements and an aesthetically shaped face section with one wide slot, for angled air discharge. For supply air, extract air or as a supply and extract air combination. For installation in lightweight partition walls with metal support structure.

Ready-to-install component which consists of the diffuser face with individually adjustable black or white air control elements, and of a plenum box with side entry spigot and acoustic lining to reduce room-to-room cross talk.

Diffuser face with screw fixing to the plenum box.

Spigot suitable for circular ducts to EN 1506 or EN 13180.

Sound power level of the air-regenerated noise measured according to EN ISO 5135.

Special characteristics

- Individually adjustable air control elements to meet individual local requirements
- High induction results in a rapid reduction of the temperature difference and airflow velocity
- Diffuser face has been optimised for maximum volume flow rate at low sound power levels
- Internal acoustic lining that reduces room-to-room cross talk through the ductwork
- For easy and safe installation of the diffuser face after drywalling is complete

Materials and surfaces

- Diffuser face made from extruded aluminium sections
- Air control elements made of plastic, UL 94, V-0, flame retardant
- Plenum box made of galvanised sheet steel
- End angle made of aluminium
- Lip seal made of rubber
- Acoustic lining of the cross-talk attenuator is mineral wool
- Diffuser face with anodised finish, E6-C-0, natural colour
- P1: Powder-coated, RAL CLASSIC colour
- Air control elements similar to RAL 9005, black
- WW: Air control elements similar to RAL 9010, white

Mineral wool

- To EN 13501, fire rating class A1, non-combustible
- RAL quality mark RAL-GZ 388
- Biosoluble and hence hygienically safe according to the German TRGS 905 (Technical Rules for Hazardous Substances) and EU directive 97/69/EC
- Faced with glass fibre fabric as a protection against abrasion through airflow velocities of up to 20 m/s
- Inert to fungal and bacterial growth

Technical data

- Nominal length 550, 1175 mm
- Number of slots: 1
- Minimum volume flow rate: 10, 25 l/s or 36, 90 m³/h
- Maximum volume flow rate, with $L_{WA} \cong 50$ dB(A): 35, 70 l/s or 126, 252 m³/h
- Supply air to room air temperature difference: -10 to +10 K

Sizing data

- V _____ [m³/h]
- Δp_t _____ [Pa]

Air-regenerated noise

- L_{WA} _____ [dB(A)]

This specification text describes the general properties of the product. Texts for variants can be generated with our Easy Product Finder design programme.

Order example: VSD50-1-LT-AZ-M-L/1175/P1-RAL 9010/WW

Construction	Supply and extract air combination
Damper blade for volume flow rate balancing	With
Accessories	Lip seal
Nominal size	1175 mm
Exposed surface	RAL 9010, pure white, gloss level 50 %
Colour of air control elements	White

VSD50 - 1 - LT - AZ - M - L / 1175 / P1 - RAL ... / WW

1 2 3 4 5 6 7

1 Type

VSD50-1-LT Slot diffuser for lightweight partition walls

2 Construction

No entry: supply or extract air
 AZ Supply and extract air combination (only nominal size 1175 mm)

3 Damper blade for volume flow rate balancing

No entry: none
 M With

4 Accessories

No entry: none
 L With lip seal

5 Nominal size [mm]

Nominal length L_N
 550
 1175

6 Exposed surface

No entry: anodised, E6-C-0, natural colour
 P1 Powder-coated, specify RAL CLASSIC colour
 Gloss level
 RAL 9010 50 %
 RAL 9006 30 %
 All other RAL colours 70 %

7 Colour of air control elements

No entry: similar to RAL 9005, black
 WW Similar to RAL 9010, white

Variants, Dimensions and weight, Product details



VSD50-1-LT/550



Black air control elements

VSD50-1-LTVSD50-1-LT-AZ

Nominal length mm L_N	L_1 mm	L_3 mm	L_4 mm	$\varnothing D$ mm	A mm	m kg
550	530	550	586	78	227	6.1
1175	1155	1175	1211	98	227	12.3

Nominal length mm L_N	L_1 mm	L_3 mm	L_4 mm	$\varnothing D$ mm	A mm	E mm	m kg
1175	1155	1175	1211	78	227	620	13.6

VSD50-1-LT

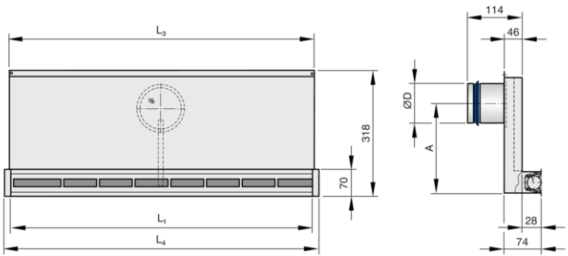

VSD50-1-LT-AZ

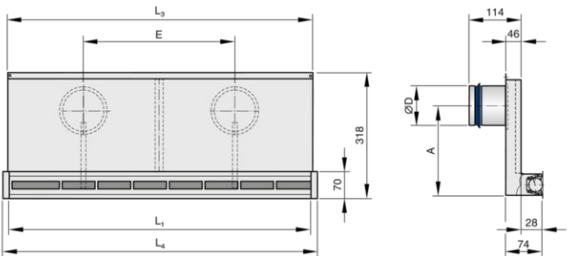

VSD50-1-LT

Profiles

A_{eff} : One-way angled air discharge (supply air)

Nominal length mm L_N	A_{eff} m^2
550	0.0055
1175	0.0118

VSD50-1-LT

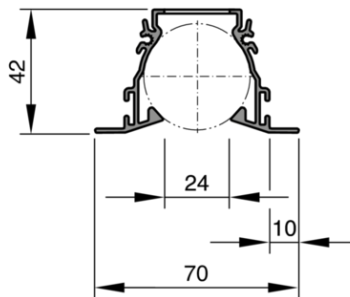

Installation details, Commissioning, Basic information and nomenclature

Installation opening

Installation and commissioning

- Preferably for rooms with a clear height up to 4.0 m
- Wall installation below the ceiling
- Installation together with drywalling
- Installation lengths correspond to the usual distances between the metal studs of stud walls
- Horizontal duct connection
- If necessary, carry out volume flow rate balancing with the damper blade

These are only schematic diagrams to illustrate installation details.

Nominal length mm L_N	l mm	h mm
550	560	58
1175	1185	58

Installation in lightweight partition walls with metal support structure

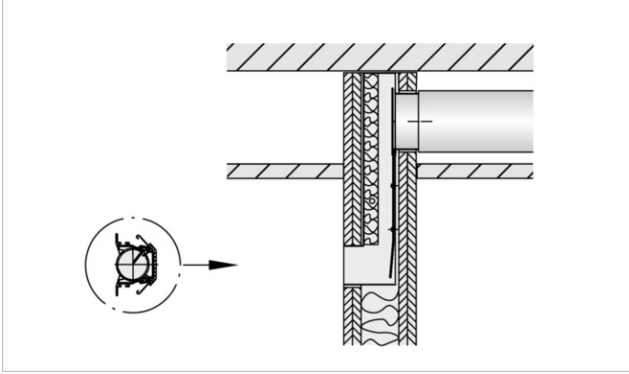

Installation opening in a lightweight partition wall

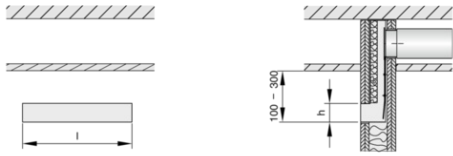

Diffuser face fixing

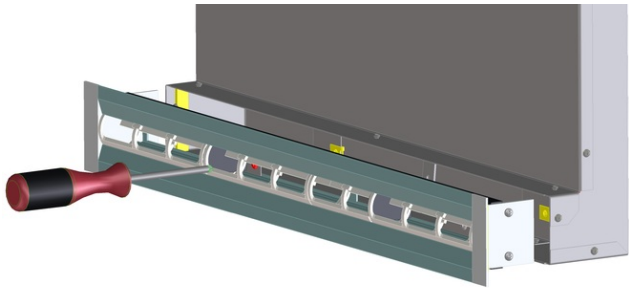

Volume flow rate balancing

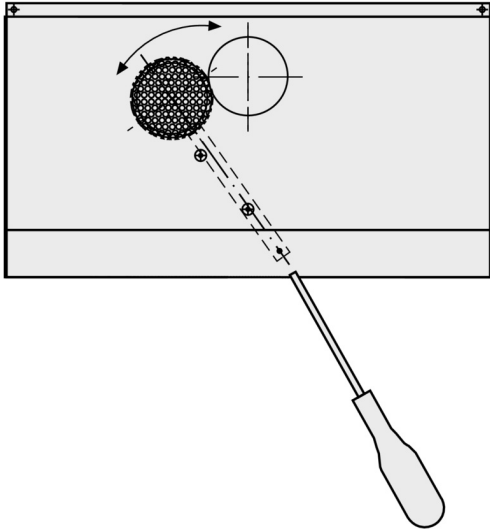

Open

Principal dimensions

ØD [mm]

Outer diameter of the spigot

L₁ [mm]

Length of diffuser without end pieces

L₃ [mm]

Length of plenum box

P [mm]

Width of diffuser face – with extended border, if any

B₃ [mm]

Width of plenum box

H₃ [mm]

Height of slot diffuser with plenum box, from the lower edge of the suspended ceiling to the upper edge of the plenum box

Y [mm]

Neck extension – The neck length results from a fixed length plus the neck extension

A [mm]

Position of the spigot, defined by the distance of the spigot centre line to the lower edge of the suspended ceiling

C [mm]

Length of the spigot

m [kg]

Weight

Nomenclature

f_m [Hz]

Octave band centre frequency

L_{WA} [dB(A)]

Sound power level of the air-regenerated noise

V [m³/h] and [l/s]

Volume flow rate

Δp_t [Pa]

Total differential pressure

All sound power levels are based on 1 pW.