



## Universal casings for duct installation of activated carbon filter cartridges

- » Universal casings for installation into ductwork
- » Fitting of activated carbon filter cartridges
- » Side service door for easy filter change



### Content overview

General information .....	2
Order code .....	3
Universal casing F341 .....	4
Universal casing F345 .....	5
Technical data .....	6
Specification text .....	7

## Detail



Universal casing for activated carbon filter cartridges

### » Application

Universal casings for installation into ductwork.  
Mounting plates for fitting of activated carbon filter cartridges for the adsorption of gaseous odorous substances and contaminants.  
Standard cell frame for fitting of filter elements for the separation of fine dust.

### » Material

Casings made of galvanised sheet steel.

### » Construction

Type F341, one stage  
- For activated carbon filter cartridges  
Type F345, two stages  
- First stage for fine dust filter elements,  
second stage for activated carbon filter cartridges

### » Equipment

- Side service door with handles and clamps. Location of the service door on the left or right when viewed in the direction of air flow.
- The casing frame with wide sealing surfaces forms the connecting frame for units or ductwork.
- Mounting plates with openings for the fastening of the activated carbon filter cartridges.
- Standard cell frame with clamping springs for secure sealing between the frame and the filter elements.

### » Construction

Delivery of larger units in component form in compact packages with connecting materials and sealant.

### » Unit size

Available in several sizes as standard.

### » Associated TROX filter elements

Associated filter elements to be ordered separately.

### » Installation and maintenance

Standard size duct casings are supplied fully assembled (with the exception of larger casings – refer to Table 3).  
Simple filter change through side service door.

## Suitable filter elements

To optimise compliance with specific requirements, various filter constructions, shapes and filter classes can be selected.

### » Activated carbon filter cartridges (F7/1/..../..)

- Type F760
- Filter media: Granulated activated carbon

### » Pocket filter inserts made of nonwoven synthetic fibres (F7/3/..../..)

- Fine dust filters: Type F728 (F7),  
Type F729 (F8)

### » Pocket filter inserts made of nonwoven glass fibres (F7/4/..../..)

- Fine dust filters: Type F748 (F7),  
Type F749 (F9)

### » Minipleat filter inserts (F7/5/..../..)

- Fine dust filters: Type F757 (F7),  
Type F759 (F9)
- Construction: frame made of plastic or galvanised sheet steel

## Order code

<table border="1" style="margin: auto;"> <tr> <td>F</td><td>3</td><td>4</td><td>1</td><td>M</td><td>1</td><td>0</td><td>0</td><td>0</td><td>L</td><td>0</td><td>0</td><td>0</td><td>0</td> </tr> <tr> <td colspan="4" style="text-align: center;">1</td> <td colspan="2" style="text-align: center;">2</td> <td colspan="2" style="text-align: center;">3</td> <td colspan="2" style="text-align: center;">4</td> <td colspan="2" style="text-align: center;">5</td> <td colspan="2" style="text-align: center;">6</td> </tr> </table>		F	3	4	1	M	1	0	0	0	L	0	0	0	0	1				2		3		4		5		6	
F	3	4	1	M	1	0	0	0	L	0	0	0	0																
1				2		3		4		5		6																	
<b>1</b> Unit type: Type F341, one stage Type F345, two stages	<b>4</b> Zeros																												
<b>2</b> Construction: M = Casing in galvanised sheet steel	<b>5</b> Code letters for service door: 0 = Service door on right when viewed in the direction of air flow L = Service door on left when viewed in the direction of air flow																												
<b>3</b> Code number: Size of the universal filter casing Refer to code numbers in Tables 2 - 3	<b>6</b> Zeros																												

**Universal casing example**

- » Unit type: **F341**
- » Construction frame made of galvanised sheet steel: **M**
- » Unit size 710 x 710 mm: **10**
- » Service door left: **L**

F	3	4	1	M	1	0	0	0	L	0	0	0	0
---	---	---	---	---	---	---	---	---	---	---	---	---	---

# Universal casing F341

## Technical data

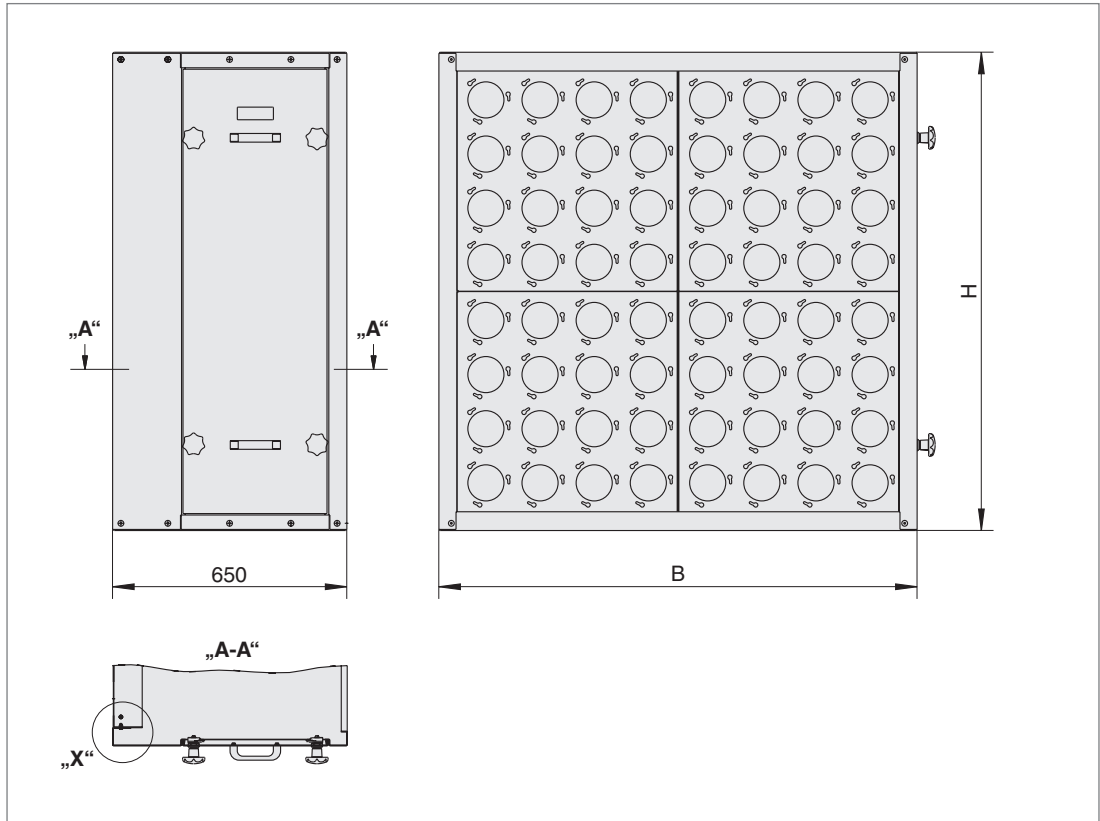

The casing frame with wide sealing surfaces forms the connection frame for units or ductwork. Maximum perimeter flange width: 40 mm.

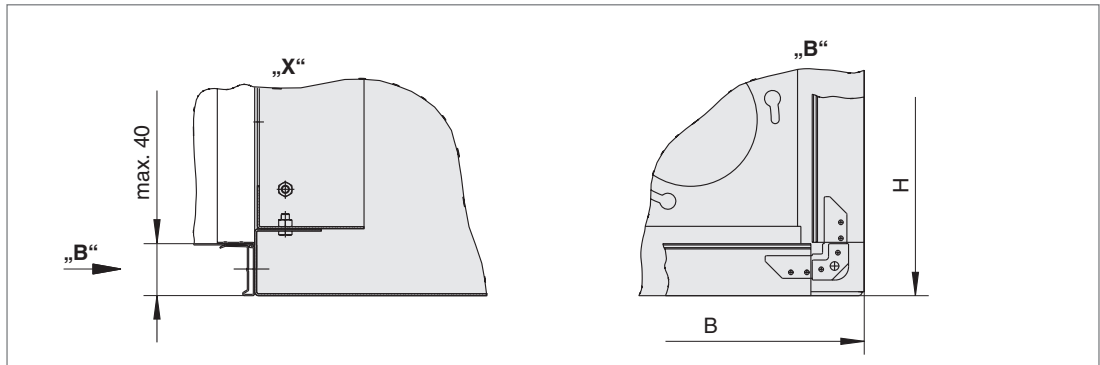

Detail drawing 2: Detail "X" and "B"

Technical data

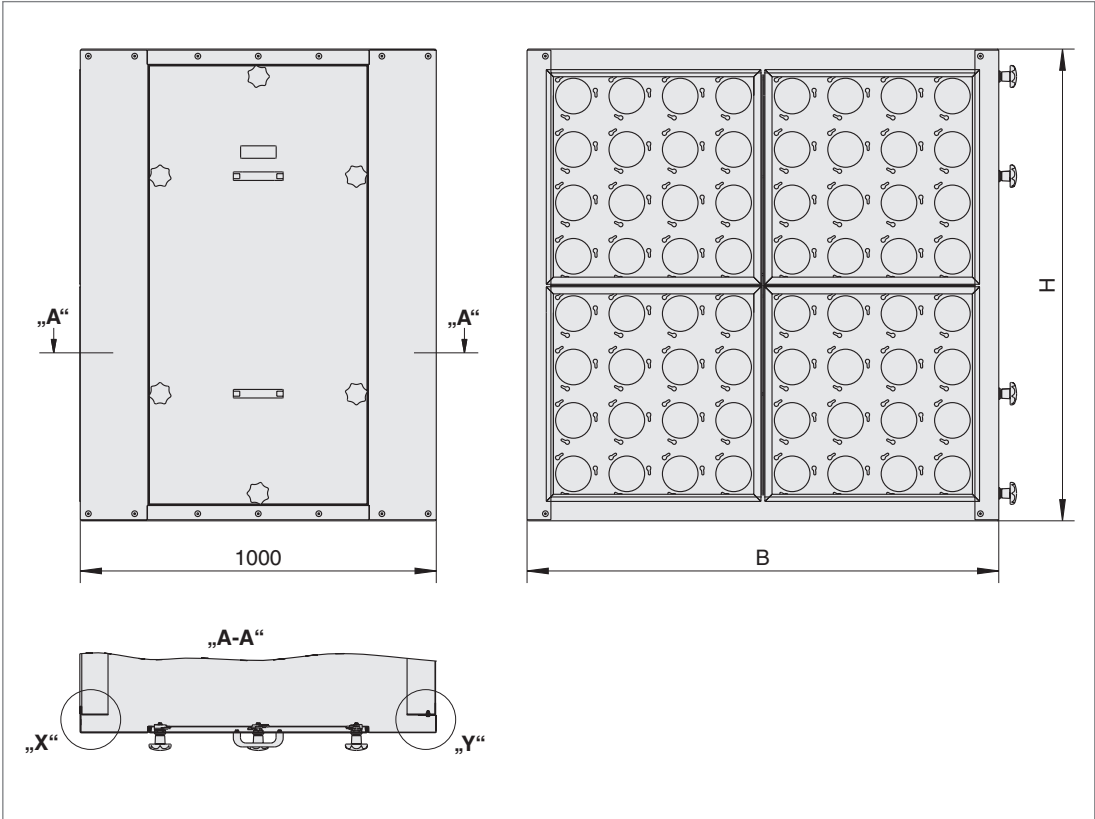

Detail drawing 3: Universal casing for duct installation F 345 (shown: service door on right)

The casing frame with wide sealing surfaces forms the connection frame for units or ductwork. Maximum perimeter flange width: 40 mm.

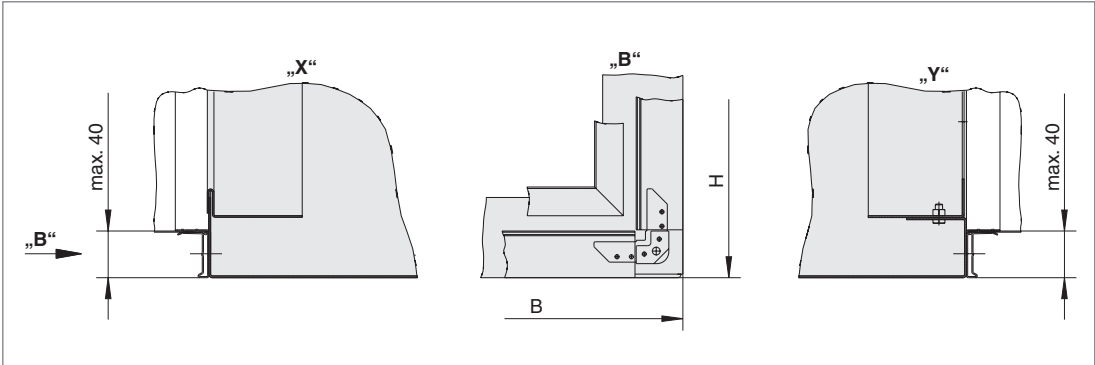

Detail drawing 4: Detail "X", "B" and "Y"

## Technical data

### Dimensions of mounting plates and standard cell frames

Size	Dimensions in mm		
	B	H	T
1/4	305	305	80
1/2	305	610	80
1	610	610	80

Table 1: Technical data for mounting plate and standard cell frame

### Dimensions for universal casings for duct installation (widths: 405 - 1940 mm)

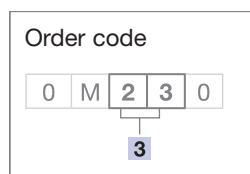
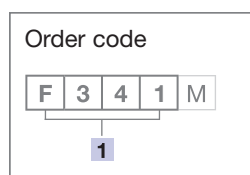

Filter elements to be ordered separately.

In case of larger volume flow rates than specified in the table, two units are combined. The service doors for the filter change are located on the right and left.

Other combinations upon request.

All weights are net, without packaging.

Dimensions in mm		Nominal volume flow rate		Quantity Mounting plates / Standard-cell frames <sup>1)</sup>			Weight <sup>2)</sup> Approx. kg	Code no. <span style="border: 1px solid black; padding: 0 2px;">3</span>
B	H	l/s	m <sup>3</sup> /h	vertical	horizontal	total <sup>3)</sup>		
405	710	470	1700	1/2	1/2	1/2	28 / 41	<b>01</b>
710	710	945	3400	1	1	1	35 / 51	<b>10</b>
710	1015	1415	5100	1 + 1/2	1	1 + 1/2	47 / 69	<b>11</b>
710	1325	1890	6800	2	1	2	57 / 81	<b>12</b>
710	1630	2360	8500	2 + 1/2	1	2 + 1/2	66 / 97	<b>13</b>
710	1940	2835	10200	3	1	3	78 / 112	<b>14</b>
710	2245	3305	11900	3 + 1/2	1	3 + 1/2	84 / 125	<b>35</b>
710	2555	3780	13600	4	1	4	100 / 137	<b>36</b>
1015	710	1415	5100	1	1 + 1/2	1 + 1/2	43 / 63	<b>15</b>
1015	1015	2125	7650	1 + 1/2	1 + 1/2	1 + 2/2 + (1/4)	59 / 83	<b>16</b>
1015	1325	2835	10200	2	1 + 1/2	2 + 2/2	69 / 97	<b>17</b>
1015	1630	3540	12750	2 + 1/2	1 + 1/2	2 + 3/2 + (1/4)	82 / 115	<b>18</b>
1015	1940	4250	15300	3	1 + 1/2	3 + 3/2	96 / 131	<b>19</b>
1015	2245	4960	17850	3 + 1/2	1 + 1/2	3 + 4/2 + (1/4)	105 / 149	<b>37</b>
1015	2555	5670	20400	4	1 + 1/2	4 + 4/2	122 / 163	<b>38</b>
1325	710	1890	6800	1	2	2	51 / 73	<b>20</b>
1325	1015	2835	10200	1 + 1/2	2	2 + 2/2	68 / 95	<b>21</b>
1325	1325	3780	13600	2	2	4	80 / 110	<b>22</b>
1325	1630	4720	17000	2 + 1/2	2	4 + 2/2	94 / 129	<b>23</b>
1325	1940	5670	20400	3	2	6	108 / 145	<b>24</b>
1325	2245	6610	23800	3 + 1/2	2	6 + 2/2	118 / 166	<b>39</b>
1325	2555	7555	27200	4	2	8	136 / 181	<b>40</b>
1630	710	2360	8500	1	2 + 1/2	2 + 1/2	60 / 89	<b>25</b>
1630	1015	3540	12750	1 + 1/2	2 + 1/2	2 + 3/2 + (1/4)	80 / 116	<b>26</b>
1630	1325	4720	17000	2	2 + 1/2	4 + 2/2	93 / 132	<b>27</b>
1630	1630	5900	21250	2 + 1/2	2 + 1/2	4 + 4/2 + (1/4)	110 / 155	<b>28</b>
1630	1940	7085	25500	3	2 + 1/2	6 + 3/2	126 / 173	<b>29</b>
1630	2245	8265	29750	3 + 1/2	2 + 1/2	6 + 5/2 + (1/4)	137 / 194	<b>41</b>
1630	2555	9445	34000	4	2 + 1/2	8 + 4/2	159 / 215	<b>42</b>
1940	710	2835	10200	1	3	3	69 / 103	<b>30</b>
1940	1015	4250	15300	1 + 1/2	3	3 + 3/2	89 / 133	<b>31</b>
1940	1325	5670	20400	2	3	6	102 / 151	<b>32</b>
1940	1630	7085	25500	2 + 1/2	3	6 + 3/2	121 / 176	<b>33</b>
1940	1940	8500	30600	3	3	9	137 / 195	<b>34</b>
1940	2245	9915	35700	3 + 1/2	3	9 + 3/2	151 / 210	<b>43</b>
1940	2555	11335	40800	4	3	12	172 / 237	<b>44</b>

Table 2: Technical data for F341 / F345

- 1) Dimensions: refer to Table 1
- 2) Construction: one stage / two stages
- 3) Quantities for plates and frames respectively for two-stage construction

## Technical data

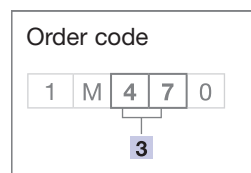
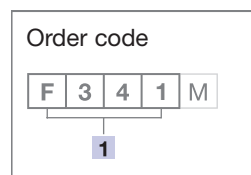

Filter elements to be ordered separately.

In case of larger volume flow rates than specified in the table, two units are combined. The service doors for the filter change are located on the right and left.

Other combinations upon request.

All weights are net, without packaging.

## Dimensions for universal casings for duct installation (widths: 2245 - 2555 mm)

Dimensions in mm		Nominal volume flow rate		Quantity			Weight <sup>2)</sup> Approx. kg	Code no. [3]
B	H	l/s	m <sup>3</sup> /h	Mounting plates / Standard-cell frames <sup>1)</sup>				
				vertical	horizontal	total <sup>3)</sup>		
2245	710	3305	11900	1	3 + 1/2	3 + 1/2	75 / 116	45
2245	1015	4960	17850	1 + 1/2	3 + 1/2	3 + 4/2 + (1/4)	100 / 149	46
2245	1325	6610	23800	2	3 + 1/2	6 + 2/2	116 / 169	47
2245	1630	8265	29750	2 + 1/2	3 + 1/2	6 + 5/2 + (1/4)	135 / 193	48
2245	1940	9915	35700	3	3 + 1/2	9 + 3/2	156 / 218	49
2245	2245	11570	41650	3 + 1/2	3 + 1/2	9 + 6/2 + (1/4)	175 / 245	50 <sup>4)</sup>
2245	2555	13220	47600	4	3 + 1/2	12 + 4/2	196 / 265	51 <sup>4)</sup>
2555	710	3780	13600	1	4	4	82 / 127	52
2555	1015	5670	20400	1 + 1/2	4	4 + 4/2	109 / 162	53
2555	1325	7555	27200	2	4	8	125 / 183	54
2555	1630	9445	34000	2 + 1/2	4	8 + 4/2	149 / 203	55
2555	1940	11335	40800	3	4	12	167 / 234	56
2555	2245	13220	47600	3 + 1/2	4	12 + 4/2	185 / 264	57 <sup>4)</sup>
2555	2555	15110	54400	4	4	16	209 / 284	58 <sup>4)</sup>

Tabelle 3: Technical data for F341 / F345

- 1) Dimensions: refer to Table 1
- 2) Construction: one stage / two stages
- 3) Quantities for plates and frames respectively for two-stage construction
- 4) For ease of transport, the universal casing will be delivered in component form

## Specification text

### Universal casings for duct installation for activated carbon filter cartridges

- » Universal casings for installation into ductwork.

#### Type F341, one stage:

- » Mounting plate for fitting of activated carbon filter cartridges for the adsorption of odourous substances and contaminants.

#### Type F345, two stages:

- » First stage: Standard cell frame for fitting of filter elements for the separation of fine dust.
- » Second stage: Mounting plate for fitting of activated carbon filter cartridges for the adsorption of odourous substances and contaminants.
- » Made of galvanised sheet steel.
- » Casing frame with wide sealing surfaces forms the connecting frame for units or ductwork.
- » Side service door (left or right) with handles and clamps.

### Technical data:

Nominal volume flow rate \_\_\_\_\_ l/s (m<sup>3</sup>/h)

Dimensions of universal casing \_\_\_\_\_ mm

Net weight \_\_\_\_\_ kg

Order number \_\_\_\_\_

Make: TROX

**TROX<sup>®</sup> TECHNIK** TROX GmbH  
The art of handling air

Siemensstraße 24  
47574 Goch, Germany  
Phone +49 (0) 28 23/10 09-0  
Fax +49 (0) 28 23/10 09-14  
E-mail [troxfilter@trox.de](mailto:troxfilter@trox.de)  
[www.troxtechnik.com](http://www.troxtechnik.com)

Filters

Subject to change / All rights reserved / © TROX GmbH (1/2010)